

DP-3030

resourceful

- Up to 30 cpm / Up to 30 ppm Digital Copying and Printing
- Standard Network Printing / Document Management Software
- Scan-to-PC / Scan-to-Email / Scan-to-FTP / Scan-to-Server Capabilities
- Standard Stackless Duplexing
- Standard Security Function

Panasonic ideas for life

WORKiO network-ready solutions

Welcome to the world of WORKiO digital imaging platforms - the true convergence of digital communications and cutting-edge imaging technology. With every new generation, WORKiO solutions deliver more versatility, higher reliability, greater ease of use, and expanded network connectivity to your business. From our flagship department-class digital MFPs and "all-around" multifunctional workgroup platforms to high-performance color printers and document scanners, Panasonic's DP-3030 again sets new standards in intuitive operation, durability, performance, and network integration.

Our latest generation offers a glimpse into the WORKiO vision for the office of tomorrow. As you experience our new "smart" visual user interface, you see how WORKiO puts the power of the most advanced office technology at your fingertips. In your exploration of our desktop document management solution, you realize that WORKiO is bringing the "paperless" office another step closer to reality. In our enhanced network connectivity, you begin to share our future vision of the "ubiquitous digital" work environment where all devices speak the same language.

Face of the Next Generation

Friendly, well-connected, and able to perform five different jobs with speed and efficiency, the new WORKiO DP-3030 is the ideal platform for workgroups. It incorporates the same advanced technology, versatility, and intuitive operation found in our department-class digital MFPs, and packs it in a reliable compact platform with performance that precisely fits your volume requirements. Serving as a complete document processing and management solution, the DP-3030 is ready to bring the digital imaging revolution to your workplace.

The DP-3030's advanced features and multifunctionality are easily accessible thanks to a revolutionary visual user interface displayed on a spacious half-VGA size touch panel. Everything is arranged according to natural workflow and organized in an intuitive tabbed interface that enables walk-up users to tackle the most challenging copying jobs and scan and electronically distribute memos directly to desktop users, and broadcast faxes over conventional phone lines or over the Internet - all with ease.

Panasonic
DP-3030

WORKIO

1010151000510100
1010100110000000
6000100110000000
0:00151511010000
1000102662011712
0000000000000000
0060000000000000

WORKiO – the Copying Solution & Network Printing Solution

fast, high-quality copying

From routine copying of your meeting notes to the production of stapled multi-page reports for the entire department, the WORKiO DP-3030 delivers up to 30 letter-size copies per minute and features ledger-size paper handling standard. The combination of 600 x 600 dpi printing resolution and 256 gray scale half tones offers the ultimate in output quality thanks to a unique new Panasonic image stabilization system that uses advanced technology to control the laser exposure time.

innovative interface

The intuitive tabbed interface on the extra-large half-VGA LCD display (640 x 240 pixels) provides quick access to basic copying functions as well as walks users through advanced settings such as image rotation and finishing options. A graphical confirmation feature helps prevent costly copying errors and can even send a completion notice directly to the user's desktop.

versatility and convenience

Enjoy amazing versatility with the built-in stackless duplex unit and Inverting Automatic Document Feeder as well as handy functions such as Double Exposure, Digital SkyShot, N-in-1 Copy, Zoom and Image Rotation. The convenient Sort Copy function electronically collates copies as shifted and rotated sets.

Double Exposure **WORKiO Original**

The DP-3030 has a versatile unique function that allows users to make quality copies of double-sided documents on a single sheet of paper without the black borders, even if the platen cover is open. This is especially convenient for copying small double-sided originals such as ID and insurance cards, checks, and receipts.

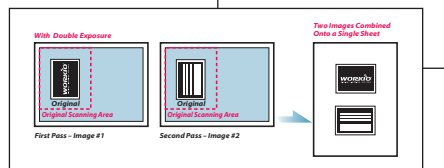

N-in-1 copy

N-in-1 Copy is a cost efficient feature. Copy multiple originals onto a single sheet of paper.

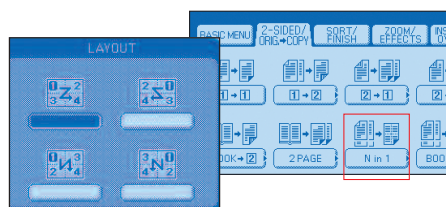

copying connectivity

Built-in connectivity enables advanced capabilities such as Tandem Copy* and Remote Copy*. For extra-large jobs with tight deadlines, Tandem Copy lets you harness the power of multiple WORKiO platforms to work jointly on a single job.

* Optional Hard Disk Drive Unit and optional Image Memory are required. These functions are available only between DP-3030/2330 and other DP-3030/2330/3010/2310 WORKiOs.

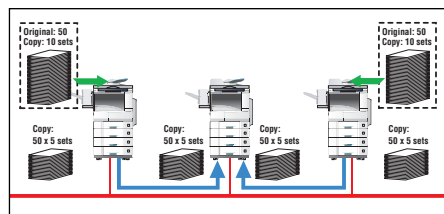

complete from start to finish

The optional finishing capabilities turn your WORKiO into a complete document solution, from start to finish. Before you press start, the DP-3030 lets you check finishing selections to prevent costly mistakes.



Image Enhancement Technology

Original WORKiO technology makes sure that very detailed graphics and small text are copied in clear detail.

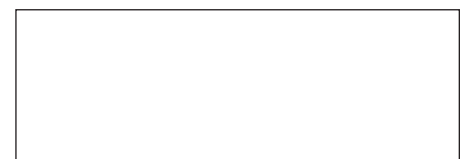

meet the friendliest interface in the office

Designed to let even a first-time user take full advantage of the many digital copying conveniences, the WORKiO GUI sets a standard in ease of use. The left-to-right menu arrangement follows the natural flow of work and takes the complexity out of the most challenging copy jobs. In the spacious layout of the large touch-screen panel, settings are presented with easy-to-understand graphics to simplify your selection.



2-sided copying for additional savings

The built-in duplex unit enables copying on both sides for higher productivity and economical savings. With the Inverting Automatic Document Feeder, copying double-sided originals is made easier. As an added benefit, a notice can be automatically printed, telling document readers to "See the other side."

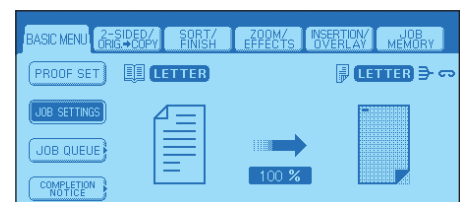

check finishing selections

You can confirm all settings from size and "Zoom/Effects" to "Sort/Finish" on the screen and prevent wasteful miscopying.

WORKiO – the Scanning & Document Distribution Solution

high-speed network scanning

With the optional Network Scanning Module, the WORKiO DP-3030 becomes a high-speed network scanner that revolutionizes document distribution. The intuitive WORKiO interface makes it easy to send scanned documents to an FTP server or PC on the LAN. The "File Naming" feature gives you the freedom to assign a name to a scanned file before you send it for easy identification. High-resolution scanning at up to 600 x 600 dpi with 256 gray scale halftone using error diffusion technology provides clear crisp image quality. With the standard inverting ADF unit, 2-sided scanning up to ledger-size is possible.



document distribution system

The optional Document Distribution System allows users to send documents to dedicated recipients automatically. Information can be received as scans, incoming faxes or even emails with attachments and routed to the right person every time saving time and money. You can even perform user defined jobs such as auto-rotation, noise reduction, skew correction, OCR text extraction and automatic file naming using OCR title extraction. Once you've used the DP-3030 to start the workflow process, the Document Distribution System can route those documents via fax, email, ftp, or send them to a network folder, a web based folder or even directly to multiple PC's desktop. Combine that with the built-in PDF conversion utility and you can get text-searchable PDF files where and when you want them.

fast faxing

Transform the DP-3030 into a high-performance fax station. With the optional fax communication kit, which adds fast 33.6 kbps Super G3 fax capability accelerated by 0.7-sec* "Quick Scanning" for shorter preparation time and Quick Memory Transmission. One of the smart features of the DP-3030 is a function that automatically switches to fax mode by determining that a telephone number is being entered when a number over 6 digits is keyed in.

*Letter portrait in Standard or Fine mode using the ADF.

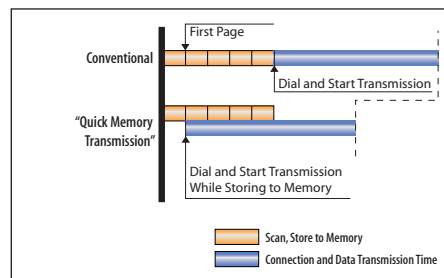

"Quick Memory Transmission"

For fax transmission of multiple pages, the WORKiO DP-3030 begins transmitting while scanning large documents.

desktop document management

The WORKiO DP-3030 also provides Document Manager software for efficient management, editing and sharing of scanned documents. For very large-scale document management based on a client-server model, the optional DD Server System* takes your business a step closer to paperless document management.

*Optional Network Scanner Module or Network Scanner Module for Document Distribution System is required.

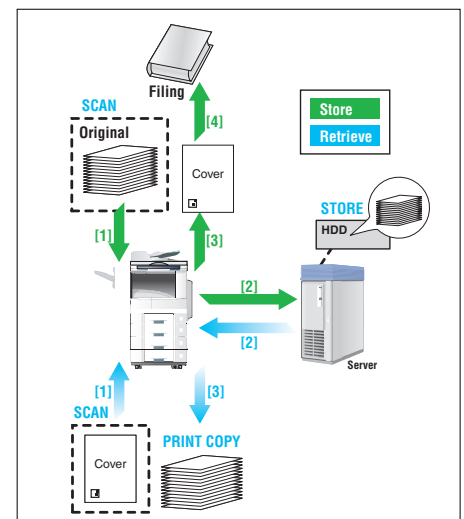

WORKiO – Options & Specifications

Hard Disk

Hard Disk Drive Unit
DA-HD30
(Optional Image Memory is required)

Image Memory Options

16MB / 64MB / 128MB
DA-SM16B / DA-SM64B / DA-SM28B

Exit Tray (Inner)

DA-XN201

Paper Exit Options

1-bin Finisher

DA-FS300

Exit Tray (Outer)

DA-XT200

Software

Accounting System

Accounting Software
DA-WA10
(Optional Hard Disk Drive Unit and
Optional Image Memory are required)

DD Server System

DD Server Software
DA-WS20
(Optional Network Scanner Module or Network Scanner
Module for Document Distribution System is required)

Document Distribution System

Panasonic Document Distribution System
DA-WR10
(Network Scanner Module for Document Distribution System is required)

Paper Feed Options

Fax / Scan-to-Email (Internet Fax) Options

Flash Memory

4MB Flash Memory / 8MB Flash Memory
UE-410047F/UE-410048F

G3 Fax

Fax Communication Board
DA-FG300

Scan-to-Email (Internet Fax)

Internet Fax/E-Mail Module
DA-NF600

Expansion Board

DA-EM600F

Printer / Network Printer Options

Printer Controller Module
DA-PC301

**Multi-Page Description Language
Controller Module**
DA-MC301

Network Scanner Option

Network Scanner

Network Scanner Module
DA-NS600

**Network Scanner Module for
Document Distribution System**
DA-NS601

Key Counter Cable Kit
DA-KH200

For Wheelchair Configurations

Full-Height Configurations

2-Paper Tray Configuration

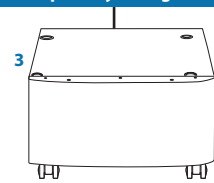

3-Paper Tray Configuration

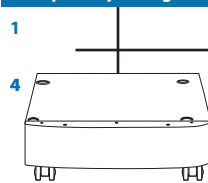

4-Paper Tray Configuration

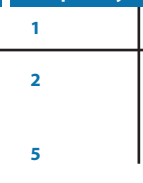

1- 3rd Paper Tray

DA-DS305

2- 4th Paper Tray

DA-DS306

3- Deluxe Stand (High)

DA-DA310R

4- Deluxe Stand (Low)

DA-DA320R

5- Base Plate with Casters

DA-DA230

2-Paper Tray Configuration

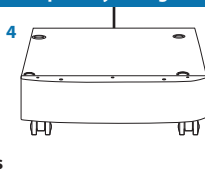

3-Paper Tray Configuration

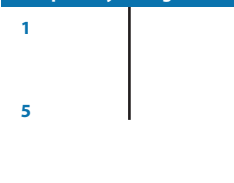

DP-3030 Specifications

General	
Type	Desktop
Copy / Print Process	Laser Indirect Electrostatic
Developing Process	Dry Dual Component
Inverting Automatic Document Feeder	50 sheets (Letter, 20 lb, 75 g/m ²)
Paper Feed	Std. 550-sheet paper tray unit x 2 + 50-sheet bypass Max. 2,250 sheets with option
Paper Weight	Paper Tray : 16 to 24 lb (60 to 90 g/m ²) Bypass: 15 to 34 lb (55 to 133 g/m ²)
Power Requirements	AC 120, 60 Hz, 12A
Power Consumption	Max.: Less than 1.5 kW Power saver mode: Approx. 28 W Sleep mode: Approx. 18 W
Warm-up Time (68°F/20°C)	Approx. 35 sec. (Main power switch ON) Approx. 30 sec. (Power saver mode)
Dimensions (W x D x H)*1 (Excluding optional equipment)	23.6" x 27.9" x 33.9" (597 x 707 x 860 mm) (Including Automatic Document Feeder and ADF mounting bracket)
Weight*1 (Excluding optional equipment)	Approx. 181 lb (82 kg)
Digital Copier	
First Copy Time	Approx. 4.5 sec. (Letter)
Resolution	600 dpi
Gray Scale	256 steps
Multi Copy Speed*2	up to 30 cpm
Maximum Original Size	Ledger
Copy Size	Ledger-Invoice (fixed)
Copy Ratio	Enlargement (fixed) 200 %, 155 %, 129 %, 121 % Reduction (fixed) 79 %, 77 %, 65 %, 61 %, 50 %
Zoom (variable)	25-400 % (in 1% increments)
Multiple Copy	1 to 999, Automatic reset to 1
Exposure Control	Text, Text/Photo, Photo
Sort Memory (Standard)	16 MB
(Option)	Base Memory (16 MB) plus 16 MB / 64 MB / 128 MB (max.144 MB) 12 GB (with optional HDD)

Printer	
Network Printer Interface	Ethernet 10Base-T/100Base-TX
Communication Protocol	TCP/IP (LPD, RAW/Port9100, SNMP, DHCP) IPX/SPX*3,4 (NDS, Bindery, NDPS), AppleTalk (PS), IPP (PCL, PS)
Local Printer Interface	USB 1.1
Printer Language (Standard) (Option)	Panasonic Printing System for Windows® PCL 5e Emulation*4, PCL 6 Emulation*4 Adobe® PostScript®3™*5
Printing Speed*2	up to 30 ppm
Paper Size	Paper Tray: Ledger-Invoice Bypass: Ledger-Invoice
Printing Resolution	1,200 dpi equivalent x 600 dpi (PCL, PS), 600 dpi x 600 dpi, 300 dpi x 300 dpi (PCL, PS, GDI)
Printer Memory	50 MB
PCL/PS Spool Memory	6 GB with optional HDD
Compatible Client Operating Systems	Windows® XP/2000/98/Me, Windows NT® 4.0, Mac® OS 8.6-10.2 (PS Only)*5
Compatible Network Operating Systems	Windows® 2000/Server 2003, NT 4.0, Novell 3.x/4.x/5.x/Unix (LPD/LPR), Linux (LPD/LPR, AS/400 (PCL, PS))
Network Scanner (Option)	
Network Scanner Interface	Ethernet 10Base-T/100Base-TX
Communication Protocol	TCP/IP (LPR, FTP)
Maximum Scanning Size	Ledger
Scanning Speed*6	Approx. 30 opm (Originals per minute – Letter portrait with ADF)
Scanning Resolution	150 dpi x 150 dpi, 300 dpi x 300 dpi, 600 dpi x 600 dpi
Compatible Operating Systems	Windows® XP/2000/Server 2003, 98, Me, Windows NT® 4.0
Data Format	TIFF, PDF
G3 Fax (Option)	
Compatibility	ITU-T Group 3, ECM
Modem Speed	33.6-2.4 kbps with automatic fallback
Coding Scheme	JBIG / MMR / MR / MH
Scanning Speed*6	Approx. 0.7 sec. (Letter portrait in Standard or Fine mode with ADF)
Transmission Speed*7	Approx. 2.7 sec.
Scanning Resolution	Standard: 203 dpi x 98 lpi (8 dots/mm x 3.85 lines/mm) Fine: 203 dpi x 196 lpi (8 dots/mm x 7.7 lines/mm) Super Fine: 406 dpi x 391 lpi (16 dots/mm x 15.4 lines/mm) 600 dpi 600 dpi x 600 dpi
Maximum Original Size	Ledger
Effective Scanning Width	10.7" (274 mm)
Recording Resolution	600 x 600 dpi
Standard Memory*8	3 MB (approx. 180 pages)
Optional Memory*8	Base memory plus 4 MB (320 pages)/8 MB (640 pages)
Speed Dials	200 (Max. 1,000 with optional HDD)
Internet Fax/Scan-to-Email (Option)*9	
Compatibility	IETF RFC 2305, ITU-T T.37**10
Communication Protocol	TCP/IP (SMTP, POP3, LDAP)
Network Connectivity	10Base-T/100Base-TX Ethernet
Data Format	TIFF (Profile S/F/J), PDF*10

Dimensions

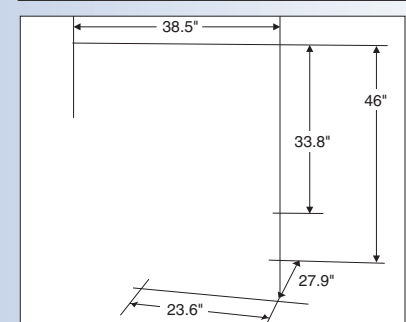

Notes

- *1 Dimensions and weight are approximate.
- *2 Speeds are contingent upon applications, machine configuration, and status. Individual speeds may vary.
- *3 Compatible with Novell Netware® 3.14/5.16 and Novell Directory Services®.
- *4 Printer Controller Module or Multi-Page Description Language Controller Module option required.
- *5 Multi-Page Description Language Controller Module option required.
- *6 Scanning speed applies to the feeding process from the top to the end of a single page test chart. The time for the feeding process does not include the time that it takes for the top edge of the page to reach the scanning point and page ejection. Time for entire starting process is not applied.
- *7 Transmission time applies to memory transmission of text data using only ITU-T Image No.1 between the same models at maximum modem speed. Transmission time may vary in actual usage. Usually public telephone lines can only support communication speeds of 28.8 Kbps or lower. Via PBX, transmission speed may fall back to a lower speed.
- *8 Based on ITU-T Image No.1 scanned in Standard mode.
- *9 Depending on the receiving machine's capability, the document may not be correctly printed depending on the chosen resolution and document size.
- *10 T.37 Internet Fax only supports TIFF format.

Design and specification are subject to change without notice. Not all options may be available at the time of notification.

Microsoft® Windows® and Windows NT® are registered trademarks of Microsoft Corporation. Adobe, PostScript and PostScript 3 are either registered trademarks or trademarks of Adobe Systems Incorporated in the United States and/or other countries. Novell Netware® and Novell Directory Services® are registered trademarks of Novell, Inc. in the United States and other countries. PCL is a registered trademark of Hewlett-Packard. WORKiO® is a registered trademark of Matsushita Electric Industrial Co., Ltd. All other brand or product names are the property of their respective holders.

Panasonic®

Panasonic Digital Document Company
Unit of Panasonic Corporation of North America

Two Panasonic Way, Secaucus, NJ 07094
For a local dealer, please call 1-800-742-8086
panasonic.com/office

ISO 9001

Quality Management System

Our business processes which produce document, information and network products, from manufacturing to marketing, conform to ISO9001 Quality Management Systems standard. Design, development, manufacture, installation, repair and maintenance of document, information and network products, their associated devices and consumables.

